

6301S type DUCTILE IRON SAFETY VALVE

CHARACTERISTICS

The 6301S safety valve is dedicated to protect the equipment from potential overpressure. This is an automatic device that closes when the pressure conditions are back to normal. It is a spring type safety valve with displaced ports and instantaneous exhaust. It has a ductile iron construction. It is delivered sealed with a closed cover, a tight cap and a testing lever. The seat and clack undergo a hardening heat treatment that ensures a high resistance to erosion. It complies with the PN 40 pressure rating standards and is certified by a UDT and VERITAS approval. It can be used on steam, gas and liquids. Setting certificate and information folder, in compliance with the 1998 decree about the safety valves monitoring, are available on request.

CONSTRUCTION STANDARDS

EC1433 certification, category IV (modules B+D)
Full lift construction in compliance with VdTÜV-Merkblatt 100
Maximum flow rate at set pressure + 10 %
UDT approval 783/JN/013/07/Z
VERITAS approval 04592/ED BV for marine and offshore use



LIMITS OF USE

Max. allowable pressure (PS)	PN 40
Testing pressure	60 bar
Allowable temperature (TS)	-10 °C / +350 °C

MAXIMUM SETTING PRESSURE (BAR)

DN	20	25	32	40	50	65	80	100
P (bar)	40	40	40	32	32	32	32	20

Minimum setting pressure: 0.5 bar

PRESSURE / TEMPERATURE DIAGRAM

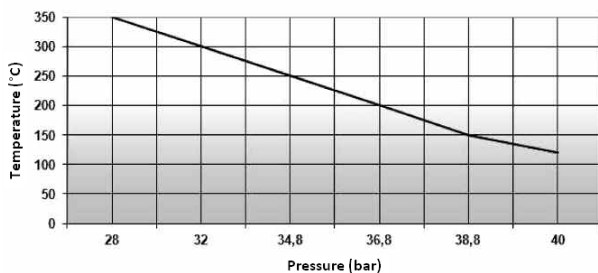

FLOW RATE COEFFICIENTS

Fluid	Setting pressure	Coefficient α
Gas and steam	< or = 14 bar	0.72
Gas and steam	> 14 bar	0.78
Liquids for b1= 10%	< or = 6 bar	0.01
Liquids for b1= 10%	> 6 bar	0.28
Liquids for b1= 25%	Any pressure	0.28

AVAILABLE ITEMS

DN 20 to 100: Flanged connections: inlet PN40-
outlet PN10/16

For common fluids (water, compressed air and steam), please consult our flow graphs

Technical data given for information purpose only. May be subject to alteration without prior notice

	OKTOGON KERESKEDELMI ÉS SZOLGÁLTATÓ KFT. 5000 Szolnok, Városmajor út 59/A. Magyarország Tel.: +36 56 422-339 – Fax: +36 56 525-013 www.oktognokft.hu / email: szolnok@oktognokft.hu	Nbr. pages	1/7
		Ref.	FT 2502 GB
		Rev.	
		Date	01/2012

6301S type DUCTILE IRON SAFETY VALVE

DIMENSIONS (mm) AND WEIGHT (kg)

DN	Port (mm)	F ₀	PN40 Inlet flange \varnothing	PN10/16 outlet flange \varnothing	S1	S2	H	Weight
20x32	16	201	105	140	85	95	345	7,5
25x40	20	314	115	150	95	105	395	9
32x50	25	491	140	165	100	110	420	13
40x65	32	804	150	185	115	130	495	19
50x80	40	1257	165	200	125	145	550	25
65x100	50	1964	185	220	140	150	660	37
80x125	63	3117	200	250	155	170	710	52
100x150	77	4657	235	285	175	180	810	77

CONSTRUCTION

#	Item	Material
1	Body	EN-GJS-400-18
2	Seat	X39 Cr Mo 17-1
3	Clack	X39 Cr Mo 17-1
4	Deflector	EN-GJS-400-15
5	Bonnet	EN-GJS-400-15
6	Stem	X 20 Cr 13
7	Cap	EN-GJS-400-15
8	Spring	Alloy steel 51CrV4

INSTALLATION

The valve has to be installed as close as possible to the device to protect. It has to be installed in a vertical position. There should be no valve between the safety valve and the device to protect. The safety valve should not support the exhaust pipework.

MATERIAL AND TEST CERTIFICATE

EN 10 204 3.1b certificate on request

OPTIONS

Calculation note
Underneath drain plug
Marine version

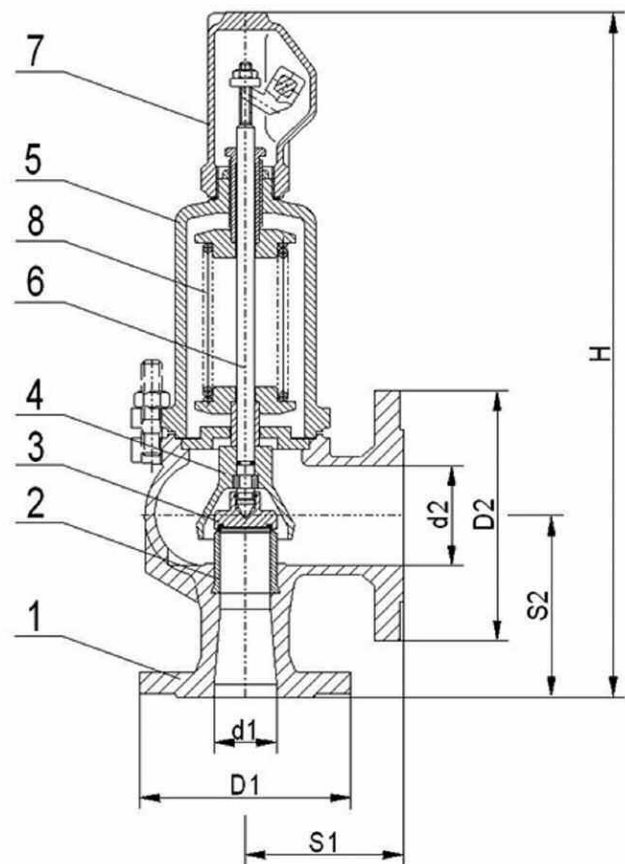

Technical data given for information purpose only. May be subject to alteration without prior notice

	OKTOGON KERESKEDELMI ÉS SZOLGÁLTATÓ KFT. 5000 Szolnok, Városmajor út 59/A. Magyarország Tel.: +36 56 422-339 – Fax: +36 56 525-013 www.oktognkft.hu / email: szolnok@oktognkft.hu	Nbr. pages	2/7
		Ref.	FT 2502 GB
		Rev.	
		Date	01/2012

6301S type DUCTILE IRON SAFETY VALVE

SATURATED STEAM FLOW RATES (t/h)

P (bar)	20	25	32	40	50	65	80	100
0,4	0,088	0,138	0,216	0,354	0,553	0,864	1,37	2,05
0,5	0,098	0,154	0,242	0,395	0,618	0,965	1,53	2,29
0,6	0,109	0,171	0,267	0,438	0,684	1,07	1,70	2,53
0,8	0,130	0,204	0,318	0,521	0,814	1,27	2,02	3,02
1	0,152	0,236	0,370	0,605	0,945	1,48	2,35	3,50
1,2	0,170	0,266	0,416	0,681	1,06	1,66	2,64	3,94
1,5	0,198	0,310	0,483	0,791	1,24	1,93	3,07	4,58
1,8	0,225	0,351	0,549	0,899	1,41	2,20	3,49	5,21
2,1	0,242	0,380	0,592	0,970	1,52	2,37	3,76	5,61
2,5	0,285	0,445	0,696	1,14	1,78	2,78	4,42	6,60
3	0,330	0,510	0,800	1,31	2,04	3,20	5,08	7,58
4	0,410	0,635	0,990	1,62	2,55	3,98	6,30	9,40
5	0,490	0,760	1,18	1,95	3,00	4,72	7,50	11,2
6	0,560	0,880	1,38	2,25	3,52	5,50	8,72	13,0
8	0,720	1,12	1,75	2,90	4,50	7,05	11,2	16,7
10	0,880	1,37	2,14	3,50	5,47	8,55	13,6	20,3
12	1,03	1,61	2,52	4,10	6,44	10,1	16,0	23,9
14	1,19	1,85	2,90	4,75	7,40	11,6	18,4	27,5
16	1,34	2,10	3,28	5,35	8,40	13,1	20,8	31,1
18	1,50	2,35	3,65	6,00	9,40	14,6	23,3	34,4
20	1,65	2,60	4,00	6,60	10,3	16,1	25,6	38,3
22	1,80	2,80	4,40	7,20	11,3	17,7	28,1	41,9
24	1,96	3,06	4,80	7,85	12,3	19,2	30,5	45,5
26	2,10	3,30	5,20	8,50	13,3	20,7	32,9	49,2
28	2,28	3,55	5,58	9,10	14,2	22,3	35,4	52,8
30	2,40	3,80	5,95	9,75	15,2	23,8	37,8	56,5
32	2,60	4,10	6,30	10,4	16,2	25,4	40,3	60,1
34	2,75	4,30	6,75	11,0	17,2	27,0	42,8	64,0
36	2,90	4,60	7,10	11,7	18,2	28,5	45,2	67,6
38	3,08	4,80	7,50	12,3	19,2	30,1	47,7	71,3
40	3,24	5,05	7,90	12,9	20,2	31,6	50,2	75,0

WATER FLOW RATES at 20 °C(t/h)

P (bar)	20	25	32	40	50	65	80	100
0,4	2,3	3,6	5,7	9,3	14,5	22,6	35,9	53,6
0,5	2,6	4,0	6,3	10,3	16,2	25,3	40,1	59,9
0,6	2,8	4,4	6,9	11,3	17,7	27,7	43,9	65,6
0,8	3,3	5,1	8,0	13,1	20,5	32,0	50,7	75,8
1	3,7	5,7	8,9	14,6	22,9	35,7	56,7	84,7
1,2	4,0	6,3	9,8	16,0	25,1	39,1	62,1	92,8
1,5	4,5	7,0	10,9	17,9	28,0	43,8	69,5	104
1,8	4,9	7,7	12,0	19,6	30,7	47,9	76,1	114
2,1	5,3	8,3	12,9	21,2	33,1	51,8	82,2	123
2,5	5,8	9,0	14,1	23,1	36,2	56,5	89,7	134
3	6,3	9,9	15,5	25,3	39,6	61,9	98,2	147
4	7,3	11,4	17,9	29,3	45,7	71,5	113	169
5	8,2	12,8	20,0	32,7	51,1	79,9	127	189
6	9,0	14,0	21,9	35,8	56,0	87,5	139	208
8	10,3	16,2	25,3	41,4	64,7	101	160	240
10	11,6	18,1	28,3	46,3	72,3	113	179	268
12	12,7	19,8	30,9	50,7	79,2	124	196	294
14	13,7	21,4	33,4	54,7	85,6	134	212	317
16	14,6	22,9	35,7	58,5	91,5	143	227	339
18	15,5	24,2	37,9	62,1	97,0	152	241	360
20	16,4	25,6	40,0	65,4	102	160	254	379
22	17,2	26,8	41,9	68,6	107	168	266	
24	17,9	28,0	43,8	71,7	112	175	278	
26	18,6	29,1	45,6	74,6	117	182		
28	19,4	30,2	47,3	77,4	121	189		
30	20,0	31,3	48,9	80,1	125	196		
32	20,7	32,3	50,5	82,8	129	202		
34	21,3	33,3	52,1					
36	21,9	34,3	53,6					
38	22,5	35,2	55,1					
40	23,1	36,1	56,5					

Technical data given for information purpose only. May be subject to alteration without prior notice

	OKTOGON KERESKEDELMI ÉS SZOLGÁLTATÓ KFT. 5000 Szolnok, Városmajor út 59/A. Magyarország Tel.: +36 56 422-339 – Fax: +36 56 525-013 www.oktogonkft.hu/ / email: szolnok@oktogonkft.hu	Nbr. pages	3/7
		Ref.	FT 2502 GB
		Rev.	
		Date	01/2012

6301S type DUCTILE IRON SAFETY VALVE

HEAT OUTPUT CAPACITY (kw) WITH A 10% OVERPRESSURE IN SATURATED STEAM

Relative pressure (bar)	20	25	32	40	50	65	80	100
0,4	55	86	134	219	343	536	849	1271
0,5	61	95	150	244	382	597	946	1416
0,6	67	105	165	270	422	660	1049	1560
0,8	80	125	195	320	500	780	1240	1854
1	93	144	226	370	578	905	1437	2140
1,2	104	162	253	415	646	1011	1608	2400
1,5	120	188	293	479	751	1169	1860	2775
1,8	136	212	331	542	850	1326	2104	3141
2,1	145	228	355	582	912	1422	2256	3366
2,5	170	265	415	680	1062	1658	2637	3937
3	196	302	474	776	1209	1896	3010	4492
4	240	372	580	949	1493	2331	3689	5504
5	284	440	684	1130	1738	2735	4346	6490
6	321	505	792	1291	2020	3156	5004	7461
8	406	632	987	1636	2539	3977	6318	9421
10	489	761	1189	1945	3039	4750	7556	11278
12	564	882	1381	2246	3529	5534	8767	13095
14	644	1001	1568	2569	4002	6274	9952	14874
16	716	1122	1752	2858	4488	6999	11113	16616
18	792	1241	1928	3169	4965	7711	12306	18168
20	862	1358	2089	3447	5379	8409	13370	20003
22	930	1447	2273	3720	5839	9145	14519	21649
24	1002	1565	2455	4014	6290	9818	15597	23267
26	1063	1670	2632	4302	6732	10478	16653	24903
28	1143	1779	2797	4561	7117	11177	17743	26465
30	1191	1886	2954	4840	7545	11814	18764	28046
32	1278	2016	3098	5113	7965	12488	19814	29549
34	1340	2095	3288	5359	8379	13154	20851	31179
36	1399	2220	3426	5646	8783	13754	21813	32623
38	1473	2295	3587	5882	9182	14394	22811	34097
40	1536	2394	3744	6114	9574	14978	23793	35548

HEAT OUTPUT CAPACITY (kw) WITH A 10% OVERPRESSURE IN HOT WATER (90 °C)

Relative pressure (bar)	20	25	32	40	50	65	80	100
0,4	270	422	660	1081	1690	2640	4190	6260
0,5	302	472	738	1208	1889	2952	4684	6999
0,6	331	517	808	1324	2069	3233	5131	7667
0,8	382	597	933	1528	2390	3734	5925	8853
1	427	667	1044	1709	2672	4174	6625	9898
1,2	468	731	1143	1872	2927	4573	7257	10842
1,5	523	817	1278	2093	3272	5112	8114	12122
1,8	573	895	1400	2293	3584	5600	8888	13279
2,1	619	967	1512	2476	3871	6049	9600	14343
2,5	675	1055	1650	2702	4224	6600	10475	15650
3	740	1156	1807	2960	4627	7230	11474	17143
4	854	1335	2087	3418	5343	8348	13249	19795
5	955	1492	2333	3821	5974	9334	14813	22132
6	1046	1635	2556	4186	6544	10225	16227	24244
8	1208	1888	2952	4833	7556	11806	18737	27995
10	1351	2110	3300	5404	8448	13200	20949	31299
12	1480	2312	3615	5919	9255	14460	22949	34287
14	1598	2497	3905	6394	9996	15618	24787	37034
16	1709	2669	4174	6835	10686	16697	26499	39591
18	1812	2831	4427	7250	11334	17710	28106	41993
20	1910	2985	4667	7642	11948	18668	29627	44264
22	2004	3130	4895	8015	12531	19579	31073	
24	2093	3269	5112	8371	13088	20449	32454	
26	2178	3403	5321	8713	13622			
28	2261	3531	5522	9042	14137			
30	2340	3655	5716	9359	14633			
32	2417	3775	5903	9666	15113			
34	2491	3891	6085					
36	2563	4004	6261					
38	2633	4114	6433					
40	2702	4221	6600					

Technical data given for information purpose only. May be subject to alteration without prior notice

	OKTOGON KERESKEDELMI ÉS SZOLGÁLTATÓ KFT. 5000 Szolnok, Városmajor út 59/A. Magyarország Tel.: +36 56 422-339 – Fax: +36 56 525-013 www.oktognkft.hu/ / email: szolnok@oktognkft.hu	Nbr. pages	4/7
		Ref.	FT 2502 GB
		Rev.	
		Date	01/2012

6301S type DUCTILE IRON SAFETY VALVE

COMPRESSED AIR FLOW RATES AT 20 °C (t/h)

P (bar)	20	25	32	40	50	65	80	100
0,4	0,132	0,206	0,323	0,528	0,826	1,290	2,05	3,06
0,5	0,148	0,232	0,362	0,593	0,928	1,450	2,30	3,44
0,6	0,169	0,264	0,412	0,675	1,060	1,65	2,62	3,91
0,8	0,202	0,316	0,493	0,808	1,260	1,97	3,13	4,68
1	0,235	0,366	0,573	0,938	1,470	2,30	3,64	5,43
1,2	0,269	0,420	0,657	1,080	1,68	2,63	4,17	6,23
1,5	0,310	0,484	0,757	1,240	1,94	3,03	4,81	7,18
1,8	0,352	0,550	0,859	1,410	2,20	3,44	5,46	8,15
2,1	0,382	0,597	0,933	1,530	2,39	3,73	5,92	8,85
2,5	0,451	0,705	1,100	1,81	2,82	4,41	7,00	10,5
3	0,523	0,817	1,280	2,09	3,27	5,11	8,10	12,1
4	0,650	1,020	1,600	2,60	4,08	6,38	10,1	15,2
5	0,785	1,230	1,92	3,13	4,90	7,65	12,2	18,2
6	0,915	1,430	2,23	3,65	5,72	8,94	14,2	21,2
8	1,180	1,84	2,88	4,70	7,35	11,5	18,3	27,3
10	1,440	2,25	3,50	5,75	9,00	14,0	22,3	33,3
12	1,70	2,66	4,15	6,80	10,6	16,6	26,4	39,4
14	1,96	3,07	4,80	7,85	12,2	19,2	30,4	45,5
16	2,22	3,48	5,43	8,88	13,9	21,7	34,5	51,5
18	2,48	3,90	6,06	9,92	15,5	24,2	38,5	57,5
20	2,74	4,30	6,70	11,0	17,1	26,8	42,6	63,6
22	3,00	4,70	7,35	12,0	18,8	29,4	46,6	69,7
24	3,28	5,10	8,00	13,0	20,4	31,9	50,7	75,7
26	3,53	5,52	8,62	14,1	22,0	34,5	54,8	81,8
28	3,80	5,93	9,25	15,2	23,7	37,0	58,8	87,8
30	4,05	6,33	9,90	16,2	25,3	39,5	62,9	93,9
32	4,30	6,74	10,5	17,2	27,0	42,1	67,0	100
34	4,57	7,15	11,2	18,3	28,6	44,6	71,0	108
36	4,70	7,56	11,8	19,3	30,2	47,2	75,0	112
38	5,10	8,00	12,5	20,4	31,8	49,7	79,0	118
40	5,30	8,40	13,1	21,4	33,4	52,3	83,2	124

COMPRESSED AIR FLOW RATES AT 20 °C (Nm³)

P (bar)	20	25	32	40	50	65	80	100
0,4	102	159	250	408	639	998	1585	2367
0,5	114	179	280	459	718	1121	1779	2660
0,6	131	204	319	522	820	1276	2026	3024
0,8	156	244	381	625	974	1524	2421	3619
1	182	283	443	725	1137	1779	2815	4200
1,2	208	325	508	835	1299	2034	3225	4818
1,5	240	374	585	959	1500	2343	3720	5553
1,8	272	425	664	1090	1701	2660	4223	6303
2,1	295	462	722	1183	1848	2885	4578	6845
2,5	349	545	851	1400	2181	3411	5414	8121
3	404	632	990	1616	2529	3952	6265	9358
4	503	789	1237	2011	3155	4934	7811	11756
5	607	951	1485	2421	3790	5916	9435	14076
6	708	1106	1725	2823	4424	6914	10982	16396
8	913	1423	2227	3635	5684	8894	14153	21114
10	1114	1740	2707	4447	6961	10828	17247	25754
12	1315	2057	3210	5259	8198	12838	20418	30472
14	1516	2374	3712	6071	9435	14849	23511	35189
16	1717	2691	4200	6868	10750	16783	26682	39830
18	1918	3016	4687	7672	11988	18716	29776	44470
20	2119	3326	5182	8507	13225	20727	32947	49188
22	2320	3635	5684	9281	14540	22738	36040	53906
24	2537	3944	6187	10054	15777	24671	39211	58546
26	2730	4269	6667	10905	17015	26682	42382	63264
28	2939	4586	7154	11756	18329	28616	45476	67904
30	3132	4896	7657	12529	19567	30549	48647	72622
32	3326	5213	8121	13302	20882	32560	51817	77340
34	3534	5530	8662	14153	22119	34493	54911	83527
36	3635	5847	9126	14927	23357	36504	58005	86620
38	3944	6187	9667	15777	24594	38438	61098	91261
40	4099	6497	10131	16551	25831	40449	64346	95901

Technical data given for information purpose only. May be subject to alteration without prior notice

	OKTOGON KERESKEDELMI ÉS SZOLGÁLTATÓ KFT. 5000 Szolnok, Városmajor út 59/A. Magyarország Tel.: +36 56 422-339 – Fax: +36 56 525-013 www.oktogonkft.hu/ / email: szolnok@oktogonkft.hu	Nbr. pages	5/7
		Ref.	FT 2502 GB
		Rev.	
		Date	01/2012

6301S type DUCTILE IRON SAFETY VALVE

6300 TYPE SAFETY VALVES MOUNTING AND MAINTENANCE INFORMATION SHEET

1. Description

- a. 6300 type spring safety valves are suitable for use on gas, steam and liquids. They ensure the ultimate protection of pressured equipment. They are able to guarantee that the internal pressure does not exceed the maximum authorized pressure, even if other safety devices installed upstream are defective, as long as they are properly sized.
- b. 6300 type spring loaded safety valves have a cast iron, carbon steel or stainless steel construction. The pressure of all the safety valves is pre-set and they are all sealed by our certified operators in order to ensure a maximum safety and a minimum maintenance level.
- c. On 6300 safety valves, closed bonnet, watertight cap and testing lever are standard equipment. Further options are available on request. The 6300 safety valves have a quick exhaust operation which is particularly recommended for steam generators or vessels containing gas. Progressive exhaust model on request.
- d. The valve body is equipped with an embossment that can be drilled to create a drain plug for the upstream pipe.

2. Warranty

- a. Before contacting us, please make sure to identify the type of safety valve as well as the individual number engraved on the safety valve body.
- b. The 6300 type safety valves are guaranteed 12 months after the delivery date. The defective pieces, after our expertise, will be replaced at our own expense. We will not accept any claim of damage caused by a wrong use, a modification of the safety valve or by a leakage due to impurities.

3. Transport, check upon delivery and storage

- a. BEWARE: the safety valve can be damaged by vibrations, shocks or impurities. Consequently, the valve has to be handled carefully without removing the protection covers or use the testing lever before installation.
- b. When delivered, please check:
 - The quality of the package
 - The conformity of the safety valve to the ordered one
 - The possible damages
 - That the safety valve is delivered with its calibration certificate, which number has to correspond to the number engraved on the safety valve body.
- c. It is recommended to install the electric actuator right after the delivery and not to leave it without using it. If the device is stored, it has to be in a dry and sheltered place

4. Precautions for use

- a. Before installation, please check that the device is depressurized and at room temperature.
- b. Any adjustment or modification has to be operated by safety valves qualified technicians only.
- c. WARNING – TOXIC GASES: If the safety valve is installed on an acid storage tank, make sure to use gloves and glasses or any other necessary protection equipment.
- d. A safety valve can be put into operation only if it is sealed and certified and if its pressure has been pre-set by SECTORIEL or any authorized body. The pre-set certificate mentions the exact pressure setting.
- e. When a free outlet safety valve has to be tested, please previously make sure that no one stays in the exhaust valve direction. Do not let toxic, explosive or flammable material exhaust in the atmosphere. Before the test, plan the controlled degassing procedure into a confined space.
- f. Do not modify the safety valve, damage its sealing or modify its pressure setting.
- g. Do not create hot or cold thermal shock on the safety valve.
- h. In the event of a malfunction, please immediately contact SECTORIEL.
- i. BEWARE: in a corrosive environment, only stainless steel safety valves should be installed.

Technical data given for information purpose only. May be subject to alteration without prior notice

	OKTOGON KERESKEDELMI ÉS SZOLGÁLTATÓ KFT. 5000 Szolnok, Városmajor út 59/A. Magyarország Tel.: +36 56 422-339 – Fax: +36 56 525-013 www.oktogonkft.hu / email: szolnok@oktogonkft.hu	Nbr. pages	6/7
		Ref.	FT 2502 GB
		Rev.	
		Date	01/2012

6301S type DUCTILE IRON SAFETY VALVE

- j. The connection type has to comply with the device piping system.
- k. If the safety valve has an atmosphere exhaust system, please direct it so that it does not cause any material or corporal damage.

5. Installation

- a. Check that the sealing is not damaged
- b. The 6300 safety valves have to be installed in a vertical position with bonnet facing up, as close as possible to the device to be protected
- c. The inlet pipework should be as short as possible, with a diameter equal or greater than the safety valve inlet flange diameter, and its length should not provoke any pressure loss exceeding 3% of the setting pressure, considering the maximum flow to be evacuated.
- d. The 6300 safety valves have a metal-to-metal tightness, which is damaged by the passage of impurities between the seat and the valve. The previous cleaning of all pipework or units is compulsory and has to be operated carefully.
- e. Remove the protection covers, taking care of not damaging the bearings, and mount the safety valve on the installation following its connection type.
- f. It is prohibited to install an isolating valve between the safety valve and the protected device.
- g. It is prohibited to install a connection with an inferior DN than the safety valve inlet DN between the safety valve and the protected device.
- h. Make sure that the piping discharge will not cause any personnel or environmental damage.
- i. If the safety valve has to be connected to pipework, please make sure that it is as short as possible in order to create the lowest back pressure possible.
- j. The exhaust piping connected to a ducted exhaust safety valve should not be supported by the safety valve itself. Otherwise, leakage might appear.
- k. If the pressure of the device has to be tested hydraulically after the installation of the safety valve, it is preferable to remove it and to replace it with a blind flange. The safety valve clack can also be blocked by a mechanical stop unit. Please make sure to remove this mechanical stop after the test.

6. Cleaning and lubrication

- a. The 6300 type safety valves are designed to avoid the need of any lubrication
- b. Maintain the safety valve clean and fully operational. For example, check that the exhaust system remains open and that no foreign body blocks the exhaust piping.

7. Routine maintenance

- a. The safety valve is a sensitive safety element that has to be verified periodically. In case of any malfunctioning, please contact SECTORIEL.
- b. BEWARE: SECTORIEL is not responsible for the safety valve effective operation if the device is dismantled, modified, or reset by anyone who is not assigned by SECTORIEL.

8. Inspection and regular maintenance

- a. Regular testing of valves is essential to maintain operational efficiency. To test it, the lever can be manually operated briefly. To protect the installation during the test, the testing pressure has to stay between 80 and 90% of the setting pressure. The safety valve should be widely open to ensure a significant flow rate. While closing, make sure that the seat remains waterproof. Beware: the testing lever has to be operated while the circuit is under pressure.
- b. If the safety valve has to be removed, it is compulsory that the maintenance or reset of the setting pressure is carried out by a specialized work qualified for this operation. The reset of the safety valve setting pressure has to be operated on a test stand equipped with a controlled manometer. In case of seat leakage, a conditioning operation might be necessary. Please contact us.
- c. For use on gas or steam installation based in France, comply with of the Decree of December, 4th 1998 relating to safety valves supervision.

Technical data given for information purpose only. May be subject to alteration without prior notice

	OKTOGON KERESKEDELMI ÉS SZOLGÁLTATÓ KFT. 5000 Szolnok, Városmajor út 59/A. Magyarország Tel.: +36 56 422-339 – Fax: +36 56 525-013 www.oktogonkft.hu / email: szolnok@oktogonkft.hu	Nbr. pages	7/7
		Ref.	FT 2502 GB
		Rev.	
		Date	01/2012