

# 6301 type CAST IRON SAFETY VALVE

## CHARACTERISTICS

The 6301 safety valve is dedicated to protect the equipment from potential overpressure. This is an automatic device that closes when the pressure conditions are back to normal. It is a spring type safety valve with displaced ports and instantaneous exhaust. It has a cast iron construction. It is delivered sealed with a closed cover, a watertight cap and a testing lever. The seat and clack undergo a hardening heat treatment that ensures a high resistance to erosion. This safety valve complies with the PN 16 pressure rating standard. It is certified by the TÜV and VERITAS approvals and can be used on steam, gas and liquids. Setting certificate and information folder, in compliance with the 1998 decree about the safety valves monitoring, are available on request.

## AVAILABLE ITEMS

Flanged connections PN10/16: DN 20 to 150

## LIMITS OF USE

Max. allowable pressure (PS)	24 bar
Allowable temperature (TS)	-10 °C / +200 °C
Max. body pressure	PN 16

## CONSTRUCTION STANDARDS

EC0045 certification, category IV (modules B+D)  
 Full lift construction in compliance with VdTÜV-Merkblatt 100  
 Maximum flow rate at set pressure + 10 %  
 TÜV approval SV 96.894 d0.D/G.∞w.p  
 VERITAS approval 22324592B00 for marine and offshore use



## PRESSURE / TEMPERATURE DIAGRAM

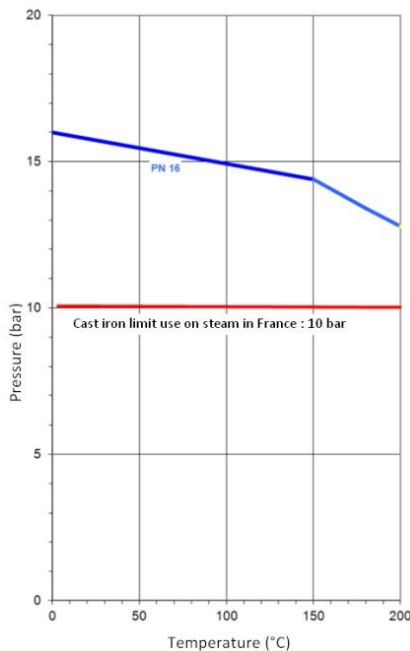

## MAXIMUM SETTING PRESSURE (BAR)

DN	20	25	32	40	50	65	80	100	125	150
P (bar)	16	16	16	16	16	16	16	16	12.5	10

Minimum setting pressure: 0.5 bar

## FLOW RATE COEFFICIENTS

Fluid	Setting pressure	Coefficient $\alpha$
Gas and steam	< or = 14 bar	0.72
Gas and steam	> 14 bar	0.78
Liquids for b1= 10%	< or = 6 bar	0.01
Liquids for b1= 10%	> 6 bar	0.28
Liquids for b1= 25%	Any pressure	0.28

For common fluids (water, compressed air and steam), please consult our flow graphs

Technical data given for information purpose only. May be subject to alteration without prior notice

	OKTOGON KERESKEDELMELI ÉS SZOLGÁLTATÓ KFT. 5000 Szolnok, Városmajor út 59/A. Magyarország Tel.: +36 56 422-339 – Fax: +36 56 525-013 <a href="http://www.oktogonkft.hu">www.oktogonkft.hu</a> / email: szolnok@oktogonkft.hu	Nbr. pages	1/6
		Ref.	FT 2501 GB
		Rev.	7
		Date	01/2012

# 6301 type CAST IRON SAFETY VALVE

## DIMENSIONS (MM) AND WEIGHT (KG)

DN	Bore	Fo	Flange Ø inlet PN16	Flange Ø outlet PN16	S1	S2	H	Weight
20x32	16	210	105	140	85	95	345	7.5
25x40	20	314	115	150	95	105	395	9
32x50	25	491	140	165	100	110	420	13
40x65	32	804	150	185	115	130	495	19
50x80	40	1257	165	200	125	145	550	25
65x100	50	1964	185	220	140	150	660	37
80x125	63	3117	200	250	155	170	710	52
100x150	77	4657	220	285	175	180	810	77
125x200	93	6793	250	340	215	220	860	90
150x250	110	9503	285	395	225	245	1000	140

## CONSTRUCTION

#	Item	Material
1	Body	EN-GJL-250
2	Seat	X39 Cr Mo 17-1
3	Clack	X39 Cr Mo 17-1
4	Deflector	EN-GJS-400-15
5	Bonnet	EN-GJL-250
6	Stem	X 20 Cr 13
7	Cap	EN-GJS-400-15
8	Spring	Alloy steel 51CrV4

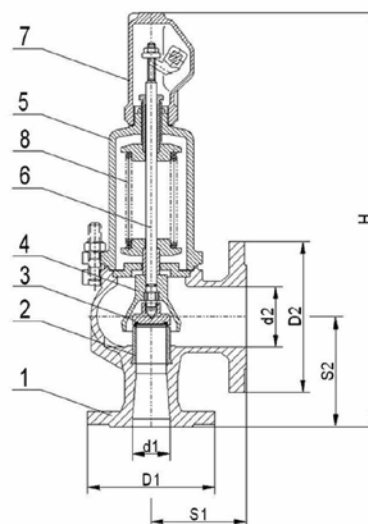

## INSTALLATION

The valve has to be installed as close as possible to the device to protect. It has to be installed in a vertical position. No valve should be between the safety valve and the device to protect. The exhaust piping should not be supported by the safety valve outlet flange.

## MATERIAL AND TEST CERTIFICATE

EN 10 204 3.1b certificate on request

## OPTIONS

Calculation note  
Underneath drain plug  
Marine version

Technical data given for information purpose only. May be subject to alteration without prior notice

	OKTOGON KERESKEDELMI ÉS SZOLGÁLTATÓ KFT. 5000 Szolnok, Városmajor út 59/A. Magyarország Tel.: +36 56 422-339 – Fax: +36 56 525-013 <a href="http://www.oktognkft.hu">www.oktognkft.hu</a> / email: szolnok@oktognkft.hu	Nbr. pages	2/6
		Ref.	FT 2501 GB
		Rev.	7
		Date	01/2012

## 6301 type CAST IRON SAFETY VALVE

### SATURATED STEAM FLOW RATES (t/h)

P (bar)	20	25	32	40	50	65	80	100	125	150	200	250	300	400
0,4	0,088	0,138	0,216	0,354	0,553	0,864	1,37	2,05	2,99	4,18	8,26	11,1	14,5	23,4
0,5	0,098	0,154	0,242	0,395	0,618	0,965	1,53	2,29	3,34	4,67	9,25	12,5	16,8	27,8
0,6	0,109	0,171	0,267	0,438	0,684	1,07	1,70	2,53	3,70	5,17	10,3	14,0	18,9	30,6
0,8	0,130	0,204	0,318	0,521	0,814	1,27	2,02	3,02	4,40	6,16	12,0	16,2	22,3	36,2
1	0,152	0,236	0,370	0,605	0,945	1,48	2,35	3,50	5,11	7,15	13,7	18,5	26,0	42,0
1,2	0,170	0,266	0,416	0,681	1,06	1,66	2,64	3,94	5,75	8,05	15,2	20,6	28,9	46,9
1,5	0,198	0,310	0,483	0,791	1,24	1,93	3,07	4,58	6,68	9,35	17,5	23,6	33,8	54,7
1,8	0,225	0,351	0,549	0,899	1,41	2,20	3,49	5,21	7,59	10,6	19,8	26,8	38,3	62,0
2,1	0,242	0,380	0,592	0,970	1,52	2,37	3,76	5,61	8,19	11,5	21,5	28,9	41,4	67,1
2,5	0,285	0,445	0,696	1,14	1,78	2,78	4,42	6,60	9,63	13,5	25,2	34,1	48,4	78,4
3	0,330	0,510	0,800	1,31	2,04	3,20	5,08	7,58	11,0	15,4	29,1	39,2	58,5	95,0
4	0,410	0,635	0,990	1,62	2,55	3,98	6,30	9,40	13,7	19,2	36,2	48,7	72,8	118
5	0,490	0,760	1,18	1,95	3,00	4,72	7,50	11,2	16,4	22,9	43,2	58,3	87,0	130
6	0,560	0,880	1,38	2,25	3,52	5,50	8,72	13,0	19,0	26,6	50,1	67,6	101	
8	0,720	1,12	1,75	2,90	4,50	7,05	11,2	16,7	24,3	34,0	64,1	86,2		
10	0,880	1,37	2,14	3,50	5,47	8,55	13,6	20,3	29,6	41,4	78,0	105		
12	1,03	1,61	2,52	4,10	6,44	10,1	16,0	23,9	34,8	48,6				
14	1,19	1,85	2,90	4,75	7,40	11,6	18,4	27,5	40,1	56,1				
16	1,34	2,10	3,28	5,35	8,40	13,1	20,8	31,1	45,3	63,4				
18	1,50	2,35	3,65	6,00	9,40	14,6	23,3	34,4	50,5	70,8				
20	1,65	2,60	4,00	6,60	10,3	16,1	25,6	38,3	55,8	78,0				
22	1,80	2,80	4,40	7,20	11,3	17,7	28,1	41,9	61,0					
24	1,96	3,06	4,80	7,85	12,3	19,2	30,5	45,5	64,4					
26	2,10	3,30	5,20	8,50	13,3	20,7	32,9	49,2	71,6					
28	2,28	3,55	5,58	9,10	14,2	22,3	35,4	52,8	77,0					
30	2,40	3,80	5,95	9,75	15,2	23,8	37,8	56,5	82,5					
32	2,60	4,10	6,30	10,4	16,2	25,4	40,3	60,1	87,8					
34	2,75	4,30	6,75	11,0	17,2	27,0	42,8	64,0						
36	2,90	4,60	7,10	11,7	18,2	28,5	45,2	67,6						
38	3,08	4,80	7,50	12,3	19,2	30,1	47,7	71,3						
40	3,24	5,05	7,90	12,9	20,2	31,6	50,2	75,0						

### WATER FLOW RATES at 20 °C(t/h)

P (bar)	20	25	32	40	50	65	80	100	125	150	200	250	300	400
0,4	2,3	3,6	5,7	9,3	14,5	22,6	35,9	53,6	78,2	109	141	293	437	709
0,5	2,6	4,0	6,3	10,3	16,2	25,3	40,1	59,9	87,4	122	158	327	489	792
0,6	2,8	4,4	6,9	11,3	17,7	27,7	43,9	65,6	95,7	134	173	359	536	868
0,8	3,3	5,1	8,0	13,1	20,5	32,0	50,7	75,8	111	155	200	414	619	1002
1	3,7	5,7	8,9	14,6	22,9	35,7	56,7	84,7	124	173	223	463	692	1120
1,2	4,0	6,3	9,8	16,0	25,1	39,1	62,1	92,8	135	189	245	507	758	1227
1,5	4,5	7,0	10,9	17,9	28,0	43,8	69,5	104	151	212	273	567	847	1372
1,8	4,9	7,7	12,0	19,6	30,7	47,9	76,1	114	166	232	300	621	928	1503
2,1	5,3	8,3	12,9	21,2	33,1	51,8	82,2	123	179	251	324	671	1002	1624
2,5	5,8	9,0	14,1	23,1	36,2	56,5	89,7	134	195	273	353	732	1094	1772
3	6,3	9,9	15,5	25,3	39,6	61,9	98,2	147	214	300	387	802	1198	1941
4	7,3	11,4	17,9	29,3	45,7	71,5	113	169	247	346	447	926	1383	2241
5	8,2	12,8	20,0	32,7	51,1	79,9	127	189	276	387	499	1036	1547	
6	9,0	14,0	21,9	35,8	56,0	87,5	139	208	303	424	547	1134	1694	
8	10,3	16,2	25,3	41,4	64,7	101	160	240	350	489	632	1310		
10	11,6	18,1	28,3	46,3	72,3	113	179	268	391	547	706			
12	12,7	19,8	30,9	50,7	79,2	124	196	294	428	599	773			
14	13,7	21,4	33,4	54,7	85,6	134	212	317						
16	14,6	22,9	35,7	58,5	91,5	143	227	339						
18	15,5	24,2	37,9	62,1	97,0	152	241	360						
20	16,4	25,6	40,0	65,4	102	160	254	379						
22	17,2	26,8	41,9	68,6	107	168	266							
24	17,9	28,0	43,8	71,7	112	175	278							
26	18,6	29,1	45,6	74,6	117	182								
28	19,4	30,2	47,3	77,4	121	189								
30	20,0	31,3	48,9	80,1	125	196								
32	20,7	32,3	50,5	82,8	129	202								
34	21,3	33,3	52,1											
36	21,9	34,3	53,6											
38	22,5	35,2	55,1											
40	23,1	36,1	56,5											

Technical data given for information purpose only. May be subject to alteration without prior notice

	OKTOGON KERESKEDELMI ÉS SZOLGÁLTATÓ KFT.	Nbr. pages	3/6
	5000 Szolnok, Városmajor út 59/A.	Ref.	FT 2501 GB
	Magyarország	Rev.	7
	Tel.: +36 56 422-339 – Fax: +36 56 525-013 <a href="http://www.oktogonkft.hu/">www.oktogonkft.hu/</a> / email: <a href="mailto:szolnok@oktogonkft.hu">szolnok@oktogonkft.hu</a>	Date	01/2012



# 6301 type CAST IRON SAFETY VALVE

## 6300 TYPE SAFETY VALVES MOUNTING AND MAINTENANCE INFORMATION SHEET

### **1. Description**

- a. 6300 type spring safety valves are suitable for use on gas, steam and liquids. They ensure the ultimate protection of pressured equipment. They are able to guarantee that the internal pressure does not exceed the maximum authorized pressure, even if other safety devices installed upstream are defective, as long as they are properly sized.
- b. 6300 type spring loaded safety valves have a cast iron, carbon steel or stainless steel construction. The pressure of all the safety valves is pre-set and they are all sealed by our certified operators in order to ensure a maximum safety and a minimum maintenance level.
- c. On 6300 safety valves, closed bonnet, watertight cap and testing lever are standard equipment. Further options are available on request. The 6300 safety valves have a quick exhaust operation which is particularly recommended for steam generators or vessels containing gas. Progressive exhaust model on request.
- d. The valve body is equipped with an embossment that can be drilled to create a drain plug for the upstream pipe.

### **2. Warranty**

- a. Before contacting us, please make sure to identify the type of safety valve as well as the individual number engraved on the safety valve body.
- b. The 6300 type safety valves are guaranteed 12 months after the delivery date. The defective pieces, after our expertise, will be replaced at our own expense. We will not accept any claim of damage caused by a wrong use, a modification of the safety valve or by a leakage due to impurities.

### **3. Transport, check upon delivery and storage**

- a. BEWARE: the safety valve can be damaged by vibrations, shocks or impurities. Consequently, the valve has to be handled carefully without removing the protection covers or use the testing lever before installation.
- b. When delivered, please check:
  - The quality of the package
  - The conformity of the safety valve to the ordered one
  - The possible damages
  - That the safety valve is delivered with its calibration certificate, which number has to correspond to the number engraved on the safety valve body.
- c. It is recommended to install the electric actuator right after the delivery and not to leave it without using it. If the device is stored, it has to be in a dry and sheltered place

### **4. Precautions for use**

- a. Before installation, please check that the device is depressurized and at room temperature.
- b. Any adjustment or modification has to be operated by safety valves qualified technicians only.
- c. WARNING – TOXIC GASES: If the safety valve is installed on an acid storage tank, make sure to use gloves and glasses or any other necessary protection equipment.
- d. A safety valve can be put into operation only if it is sealed and certified and if its pressure has been pre-set by SECTORIEL or any authorized body. The pre-set certificate mentions the exact pressure setting.
- e. When a free outlet safety valve has to be tested, please previously make sure that no one stays in the exhaust valve direction. Do not let toxic, explosive or flammable material exhaust in the atmosphere. Before the test, plan the controlled degassing procedure into a confined space.
- f. Do not modify the safety valve, damage its sealing or modify its pressure setting.
- g. Do not create hot or cold thermal shock on the safety valve.
- h. In the event of a malfunction, please immediately contact SECTORIEL.

Technical data given for information purpose only. May be subject to alteration without prior notice

	OKTOGON KERESKEDELMI ÉS SZOLGÁLTATÓ KFT. 5000 Szolnok, Városmajor út 59/A. Magyarország Tel.: +36 56 422-339 – Fax: +36 56 525-013 <a href="http://www.oktogonkft.hu">www.oktogonkft.hu</a> / email: <a href="mailto:szolnok@oktogonkft.hu">szolnok@oktogonkft.hu</a>	Nbr. pages	5/6
		Ref.	FT 2501 GB
		Rev.	7
		Date	01/2012

# 6301 type CAST IRON SAFETY VALVE

- i. BEWARE: in a corrosive environment, only stainless steel safety valves should be installed.
- j. The connection type has to comply with the device piping system.
- k. If the safety valve has an atmosphere exhaust system, please direct it so that it does not cause any material or corporal damage.

## 5. Installation

- a. Check that the sealing is not damaged
- b. The 6300 safety valves have to be installed in a vertical position with bonnet facing up, as close as possible to the device to be protected
- c. The inlet pipework should be as short as possible, with a diameter equal or greater than the safety valve inlet flange diameter, and its length should not provoke any pressure loss exceeding 3% of the setting pressure, considering the maximum flow to be evacuated.
- d. The 6300 safety valves have a metal-to-metal tightness, which is damaged by the passage of impurities between the seat and the valve. The previous cleaning of all pipework or units is compulsory and has to be operated carefully.
- e. Remove the protection covers, taking care of not damaging the bearings, and mount the safety valve on the installation following its connection type.
- f. It is prohibited to install an isolating valve between the safety valve and the protected device.
- g. It is prohibited to install a connection with an inferior DN than the safety valve inlet DN between the safety valve and the protected device.
- h. Make sure that the piping discharge will not cause any personnel or environmental damage.
- i. If the safety valve has to be connected to pipework, please make sure that it is as short as possible in order to create the lowest back pressure possible.
- j. The exhaust piping connected to a ducted exhaust safety valve should not be supported by the safety valve itself. Otherwise, leakage might appear.
- k. If the pressure of the device has to be tested hydraulically after the installation of the safety valve, it is preferable to remove it and to replace it with a blind flange. The safety valve clack can also be blocked by a mechanical stop unit. Please make sure to remove this mechanical stop after the test.

## 6. Cleaning and lubrication

- a. The 6300 type safety valves are designed to avoid the need of any lubrication
- b. Maintain the safety valve clean and fully operational. For example, check that the exhaust system remains open and that no foreign body blocks the exhaust piping.

## 7. Routine maintenance

- a. The safety valve is a sensitive safety element that has to be verified periodically. In case of any malfunctioning, please contact SECTORIEL.
- b. BEWARE: SECTORIEL is not responsible for the safety valve effective operation if the device is dismantled, modified, or reset by anyone who is not assigned by SECTORIEL.

## 8. Inspection and regular maintenance

- a. Regular testing of valves is essential to maintain operational efficiency. To test it, the lever can be manually operated briefly. To protect the installation during the test, the testing pressure has to stay between 80 and 90% of the setting pressure. The safety valve should be widely open to ensure a significant flow rate. While closing, make sure that the seat remains waterproof. Beware: the testing lever has to be operated while the circuit is under pressure.
- b. If the safety valve has to be removed, it is compulsory that the maintenance or reset of the setting pressure is carried out by a specialized work qualified for this operation. The reset of the safety valve setting pressure has to be operated on a test stand equipped with a controlled manometer. In case of seat leakage, a conditioning operation might be necessary. Please contact us.
- c. For use on gas or steam installation based in France, comply with of the Decree of December, 4<sup>th</sup> 1998 relating to safety valves supervision.

 Technical data given for information purpose only. May be subject to alteration without prior notice. OKTOGON KÉSZÉKÉPÍTÉS SZOLGÁLTATÓ KFT. 5000 Szolnok, Városmajor út 59/A. Magyarország Tel.: +36 56 422-339 – Fax: +36 56 525-013 <a href="http://www.oktogonkft.hu">www.oktogonkft.hu</a> / email: <a href="mailto:szolnok@oktogonkft.hu">szolnok@oktogonkft.hu</a>	Nbr. pages	6/6
	Ref.	FT 2501 GB
	Rev.	7
	Date	01/2012